

ARTICULO: 2108A

Válvula de mariposa tipo LUG.

Butterfly valve LUG type.

Características

1. Válvula de mariposa tipo Lug.
2. Cuerpo de fundición Nodular GGG-40 para montaje entre bridas ANSI 125 / 150.
3. Elastómero de EPDM.
4. Disco de acero Inoxidable 316 (CF8M).
5. Brida montaje actuadores según ISO 5211 – DIN 3337.
6. Longitud entre caras según UNE EN 558-1 Serie 20 (DIN 3202 K1).
7. Pintado con pintura Epoxi.
8. Máxima presión de trabajo:
235 psi (medidas 2" a 12")
150 psi (medidas 14" a 24")
9. Temperatura de trabajo -20°C +120 °C.

Features

1. Butterfly valve Lug type.
2. GGG-40 Ductil Iron body allows installation between ANSI 125 / 150 pipe flanges.
3. EPDM body seat.
4. Butterfly disc made in Stainless steel 316 (CF8M).
5. Actuator mounting plate according ISO 5211 – DIN 3337.
6. Face to face according UNE EN 558-1 Series 20 (DIN 3202 K1).
7. Epoxy painted.
8. Maximum working pressure:
235 psi (sizes 2" to 12")
150 psi (sizes 14" to 24")
9. Working Temperature -20°C + 120 °C.

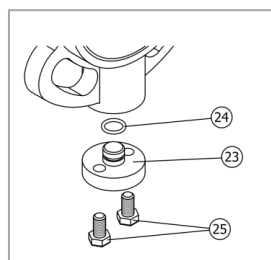
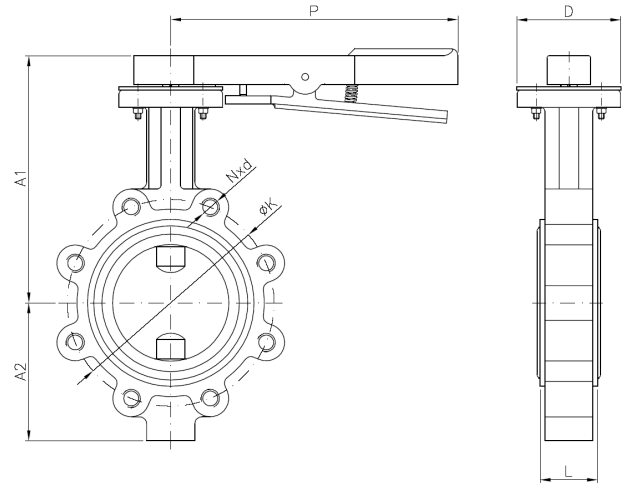
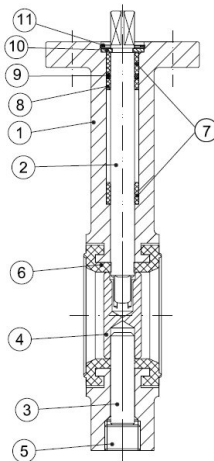

**Solamente /
Only ≥ 14"**

Nº	Denominación / Name	Material	Acabado Superficial / Surface Treatment
1	Cuerpo / Body	Fundición GGG-40 / Ductil iron GGG-40	Pintado Epoxi / Epoxy Painted
2	Eje / Stem	Acero Inox AISI 416 / SS 416	-----
3	Pivote / Pivot	Acero Inox AISI 416 / SS 416 (hasta 12" / until 12")	-----
4	Disco / Disc	Acero Inox AISI 316 / SS 316	Granallado / Shot Blasting
5	Tapón / Plug	Acero Carbono / Carbon Steel (hasta 12" / until 12")	Cincado / Zinc Plated
6	Elastómero / Seat	EPDM	-----
7	Casquillo / Bush	PTFE + Grafito	-----
8	Casquillo / Bush	PTFE + Grafito	-----
9	Tórica / O' ring	NBR	-----
10	Arandela / Washer	Bronze	-----
11	Seguro / Stop Ring	Acero / Steel	-----
12	Placa dentada / Plate	Acero / Steel	Cincado / Zinc Plated
13	Palanca / Handle	Aluminium / Cast iron GG-20	Pintado Epoxi / Epoxy Painted
23	Tapón /	Acero Carbono / Carbon Steel ($\geq 14"$)	Pintado Epoxi / Epoxy Painted
24	Tórica / O'ring	NBR ($\geq 14"$)	-----
25	Tornillo / Bolt	Acero Carbono / Carbon Steel ($\geq 14"$)	Cincado / Zinc Plated

DIMENSIONES GENERALES / GENERAL DIMENSIONS

Ref	Medida / Size	L	Dimensiones / Dimensions (mm)							Peso / Weight (kg)
			A1	A2	D	P	J	ØK	N x d (UNC)	
2108A 09	2"	43	240	79	90	216	****	121	4 x 5/8"-11	4,500
2108A 10	2 1/2"	46	240	93	90	216	****	139,7	4 x 5/8"-11	5,000
2108A 11	3"	46	245	103	90	216	****	152,4	4 x 5/8"-11	5,200
2108A 12	4"	52	265	120	90	216	****	190,5	8 x 5/8"-11	8,200
2108A 13	5"	56	290	133	90	216	****	215,9	8 x 3/4"-10	10,000
2108A 14	6"	56	240	158	125	300	****	241	8 x 3/4"-10	13,500
2108A 16	8"	60	280	180	125	300	****	298,4	8 x 3/4"-10	17,500
2108A 18	10"	68	325	216	125	300	****	361,9	12 x 7/8"-9	28,200
2108A 20	12"	78	351	251	150	Ø290	240	431,8	12 x 7/8"-9	53,000
2108A 22	14"	78	346	262	150	Ø290	257	476,3	12 x 1"-8	69,000
2108A 24	16"	102	375	301	175	Ø290	257	539,8	16 x 1"-8	97,000
2108A 26	18"	114	400	333	175	Ø400	306	577,9	16 x 1 1/8"-8	143,000
2108A 28	20"	127	432	366	175	Ø400	306	635	20 x 1 1/8"-8	180,000
2108A 32	24"	152	632	427	210	Ø400	342	749,3	20 x 1 1/4"-7	330,000

*** Nota: A partir de 12" (DN 300) operación mediante reductor manual.

*** Note: From 12" included, handling by gear operator.

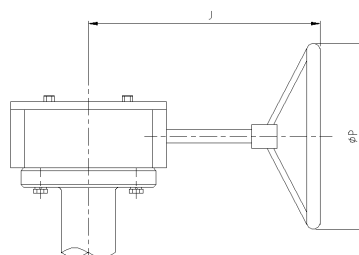

Dimensiones de brida superior / Top flange dimensions:

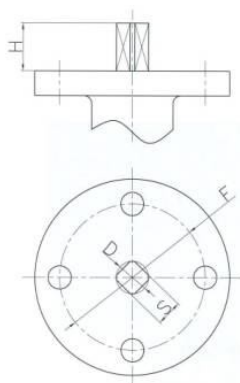

Dimensiones Brida Superior / Top Flange Dimensions						
Ref.	Medida / Size	F (ISO 5211)	S mm	D mm	H mm	Torque Nm
2108A 09	2"	F07	11	14	30	12
2108A 10	2 ½"	F07	11	14	30	20
2108A 11	3"	F07	11	14	30	27
2108A 12	4"	F07	14	18	30	40
2108A 13	5"	F07	14	18	30	60
2108A 14	6"	F07 – F10	17	22	30	90
2108A 16	8"	F07 – F10	17	22	30	120
2108A 18	10"	F10	22	28	30	180
2108A 20	12"	F10 – F12	22	28	30	340
2108A 22	14"	F12	22	28	45	640
2108A 24	16"	F14	27	36	45	805
2108A 26	18"	F14	27	36	45	1100
2108A 28	20"	F14	36	48	45	1500
2108A 32	24"	F16	xxx	Ø 50	70	3000

Perdidas de Carga (Cv) según posición del disco / Head losses (Cv) according to disc position:

Medida / Size	Posición del Disco (grados) / Disc Position (degrees)								
	90°	80°	70°	60°	50°	40°	30°	20°	10°
2"	144	114	84	61	43	27	16	7	1
2 ½"	282	223	163	107	67	43	24	11	1.5
3"	461	364	267	154	96	61	35	15	2
4"	841	701	496	274	171	109	62	27	3
5"	1376	1146	775	428	268	170	98	43	5
6"	1850	1542	1025	567	354	225	129	56	6
8"	3316	2842	1862	1081	680	421	241	102	12
10"	5430	4525	2948	1710	1076	667	382	162	19
12"	8077	6731	4393	2563	1594	1005	555	235	27
14"	10538	8874	5939	3384	2149	1320	756	299	34
16"	13966	11761	7867	4483	2847	1749	1001	397	45
18"	17214	14496	10065	5736	3643	2237	1281	507	58
20"	22339	18812	12535	7144	4536	2786	1595	632	72
24"	31850	26320	14870	9540	5320	3510	1970	915	270

VALORES DE Cv / Cv VALUES

Cv = Es la cantidad de galones por minuto (gpm) que pasará a través de la válvula generando una pérdida de carga de 1 psi.

Cv = The flow rate of water (g.p.m.) which generates a pressure drop of 1 psi across the valve.

Medidas de Precaución para la instalación / Precautions for Installation:

1. No instale la válvula en posición totalmente cerrada / *Do not assemble the butterfly valve in total closed position.*
2. Verifique el buen paralelismo de las bridas / *Check the good parallelism of the flanges.*
3. No coloque otras juntas entre las bridas / *Do not insert others gasket between flange and valve.*

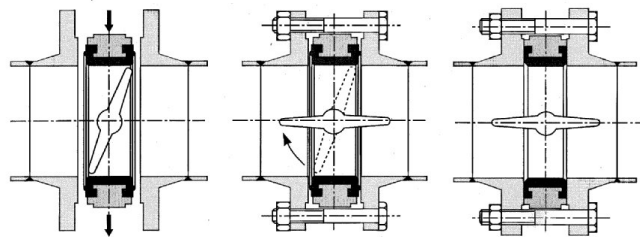

4. Si la válvula va a ser instalada al final de la tubería las presiones máximas de trabajo son: / *If the valve is installed at the end of the pipe the maximum working pressures are as following:*

From 2" to 12" 235 psi x 0.4 = 94 psi

From 14" to 24" 150 psi x 0.4 = 60 psi

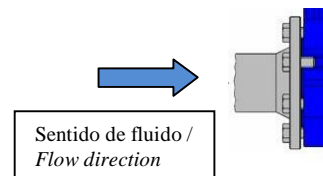

CURVA PRESION TEMPERATURA / *PRESSURE TEMPERATURE RATING*

