

## KEYSTONE F89 PNEUMATIC QUARTER-TURN ACTUATOR

GENERAL PURPOSE / HAZARDOUS AREA



### FEATURES

- Direct mounting to all Keystone butterfly valves and ball valves.
- Valve connection compatible with Keystone (imperial and metric) and ISO 5211.
- Double Rack and Pinion design nullifies side loads on the pinion shaft, minimizing bearing wear and extending life.
- Optimized product flow with standard mounted travel stops for valve position adjustment in open and close position (+/- 5° at each end).
- Anodized aluminium body with electrostatic powder coating (ESPC) finish provides durable protection against corrosive environments.
- Double acting and spring return versions available for cost effective and safe operation.
- Up to 12 individual springs offer flexible torque range for both ball as butterfly valves.
- Pre-compressed spring design and anti-blowout drive pinion means safe maintenance and operation.

### MATERIALS

Body: Extruded aluminium (ESPC coated)  
End caps: Cast aluminium (ESPC coated)

### MOUNTING SPECIFICATIONS

Actuator to valve: ISO and Keystone standard  
Accessories: Namur VDI/VDE 3845

### TECHNICAL DATA

Torque output range:  
Double acting: 11 - 4173 Nm (97 - 36955 in-lb)  
Spring return: 6 - 1663 Nm (51 - 14729 in-lb)  
Operating medium: Compressed air  
(dry or lubricated)  
Air supply pressure: 8.3 bar (120 psi) max. dynamic  
10 bar (140 psi) max. static  
Travel adjustment: +/- 5° at each end of travel  
0-100% travel stop available on request  
Temperature range: -20°C to +80°C  
(-4°F to +176°F)  
Low temp version: -40°C to +65°C  
(-40°F to +149°F)  
High temp version: -15°C to +150°C  
(5°F to +302°F)  
Certification: ATEX II 2 GD IIC T6

# KEYSTONE F89 PNEUMATIC QUARTER-TURN ACTUATOR

## GENERAL PURPOSE / HAZARDOUS AREA

### PRINCIPLE OF OPERATION

Both the double acting and spring return actuators feature a compact design each with their own set of end caps. The unit can be converted from double acting to single acting (or reverse) in the field without the requirement of special tools. The spring return actuator is available with spring sets representing 2.8 bar (40 psi) to 8.3 bar (120 psi) in 0.7 bar (10 psi) increments. The springs are manufactured from heavy gauge wire to assure long life and ESPC coated for corrosion resistance. They are pre-compressed using a special container to ensure safe operation and maintenance.

The dual-keyed output shaft allows parallel or perpendicular mounting to the valve flow direction. In normal conditions the actuator is mounted in parallel with the valve flow direction, operating in a counter clockwise (CCW) rotation from the closed to the open position.

### DOUBLE ACTING

#### To open valve

In a double acting application, air pressure is introduced to Port 2 (A), pressurizing the space between the pistons and driving the pistons out towards the actuator ends. The volume of air above the piston heads is exhausted to atmosphere. This causes the piston racks to drive the pinion in a counterclockwise direction, resulting in a quarterturn rotation. This rotation is transferred to the valve shaft, opening the valve.

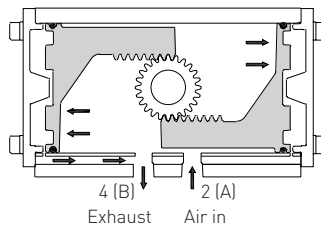

The standard operation direction of the spring fail close action is clockwise (CW). By rotating the pistons 180 degrees in the body in relation to the pinion, the actuator operation direction can be reversed. Although rotating the actuator 90 degrees will have a similar effect, the piston rotation is preferred as it maintains the parallel mounting and keeps the valve operation in the correct quadrant.

#### To close valve

Air pressure introduced to Port 4 (B), pressurizes the spaces above each piston head and drives the pistons inward. The volume of air between the pistons is exhausted to atmosphere. This causes the piston racks to drive the pinion in a clockwise direction, resulting in a quarter-turn rotation. This rotation is transferred to the valve shaft, closing the valve.

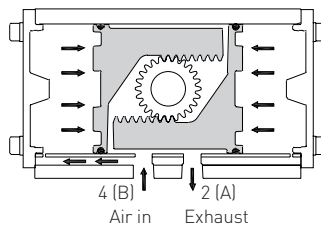

### SPRING RETURN

#### To open valve

In a single acting application, air pressure is introduced to Port 2 (A), pressurizing the space between the pistons and driving the pistons out towards the actuator ends while at the same time compressing the springs. This causes the piston racks to drive the pinion in a counterclockwise direction, resulting in a quarter-turn rotation. This rotation is transferred to the valve shaft, opening the valve.

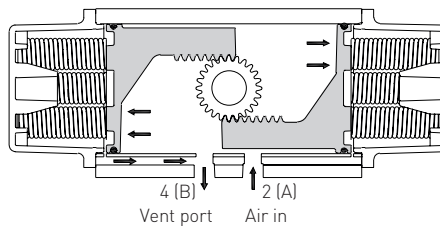

#### To close valve

When the air pressure is relieved, the spring tension moves the pistons inward and exhausts the air through Port 2 (A). This causes the piston racks to drive the pinion in a clockwise direction, resulting in a quarter-turn rotation. This rotation is transferred to the valve shaft, closing the valve.

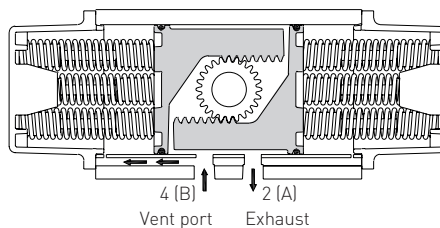

# KEYSTONE F89 PNEUMATIC QUARTER-TURN ACTUATOR

GENERAL PURPOSE / HAZARDOUS AREA

## TRAVEL ADJUSTMENT

Within the mechanical connections of the drive between the valve and the actuator there are several points of manufacturing tolerance, including valve disc or ball to stem, stem to adapter, and adapter to actuator that must be compensated for in the operation of the assembly. Therefore, adjustment is necessary to ensure that valve operation is as precise as required. The F89 dual travel stops allow  $\pm 5^\circ$  adjustment at both ends of the stroke, resulting in a total stroke range of  $80^\circ$  to  $100^\circ$  rotation. For special applications an optional linear travel stop is available, which reduces the stroke from 0-100%.

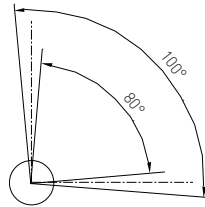

### Resilient seated butterfly valves

Shut-off occurs before the disc has rotated a full  $90^\circ$  from the open position. Travel adjustment is therefore desirable to prevent over travel, which would result in unnecessary operating torque and premature deterioration of seat life. In the open position, adjustment is necessary to ensure maximum flow through the valve and minimum dynamic forces acting on the disc.

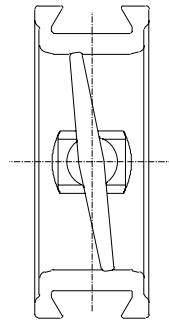

### High performance butterfly valves

The double offset design of high performance butterfly valves results in the disc moving into the seat with a camming action. It is important that the disc does not travel beyond the seat position, otherwise damage to the seat will occur.

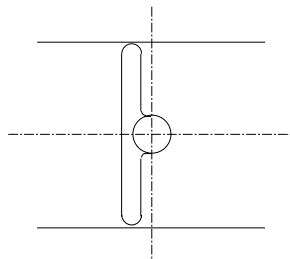

### Ball and plug valves

The ball or plug must be precisely in line with the valve port to prevent damage to the seat in the open position. Adjustment at the closed position is necessary to ensure that complete shut-off is achieved.

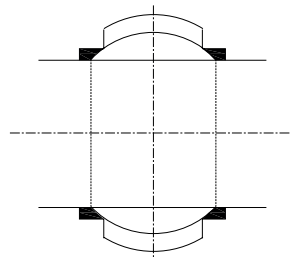

# KEYSTONE F89 PNEUMATIC QUARTER-TURN ACTUATOR

GENERAL PURPOSE / HAZARDOUS AREA

## DIMENSIONS

Top view

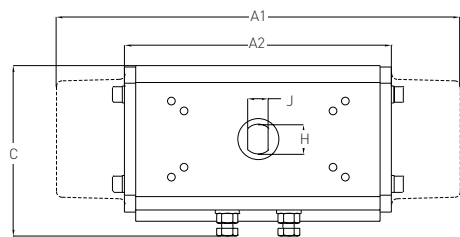

Bottom view

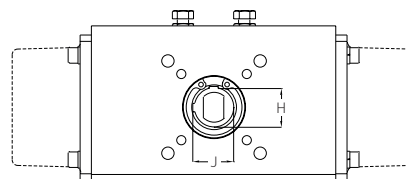

Side view

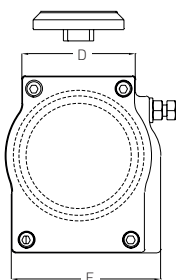

Front view

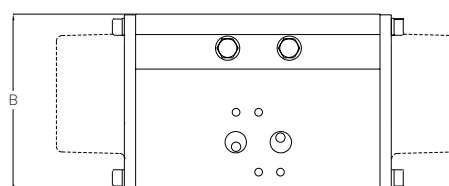

TABLE 1 - DIMENSIONS F89 METRIC (mm)

| Model           | A1 <sup>(1)</sup> | A2 <sup>(1)</sup> | B   | C   | D   | E   | Top of shaft <sup>(2)</sup> |                |     |
|-----------------|-------------------|-------------------|-----|-----|-----|-----|-----------------------------|----------------|-----|
|                 |                   |                   |     |     |     |     | H                           | J              | Key |
| F89-002         | -                 | 121               | 72  | 74  | 54  | 66  |                             | DD 16.0 x 11.0 |     |
| F89-003         | 186               | 125               | 86  | 81  | 59  | 79  |                             | DD 16.0 x 11.0 |     |
| F89-004         | 217               | 143               | 96  | 91  | 61  | 80  |                             | DD 16.0 x 11.0 |     |
| F89-006         | 259               | 169               | 101 | 108 | 64  | 87  |                             | DD 16.0 x 11.0 |     |
| F89-009         | 257               | 174               | 119 | 124 | 64  | 99  |                             | DD 16.0 x 11.0 |     |
| F89-014         | 307               | 193               | 138 | 141 | 78  | 112 |                             | DD 16.0 x 11.0 |     |
| F89-020         | 378               | 236               | 155 | 157 | 81  | 123 |                             | DD 16.0 x 11.0 |     |
| F89-032/033     | 462               | 283               | 171 | 182 | 95  | 136 | 20.7                        | 21.4           | 4.8 |
| F89-051/052     | 476               | 298               | 213 | 210 | 111 | 159 | 20.7                        | 21.4           | 4.8 |
| F89-084/085/086 | 627               | 384               | 227 | 233 | 130 | 190 | 25.5                        | 27.0           | 6.4 |
| F89-139/140/141 | 726               | 431               | 274 | 288 | 154 | 233 | 25.5                        | 27.0           | 6.4 |
| F89-240         | 845               | 507               | 325 | 341 | 186 | 290 | 25.5                        | 27.0           | 6.4 |

TABLE 2 - DIMENSIONS F89 IMPERIAL (in)

| Model           | A1 <sup>(1)</sup> | A2 <sup>(1)</sup> | B     | C     | D    | E     | Top of shaft <sup>(2)</sup> |               |      |
|-----------------|-------------------|-------------------|-------|-------|------|-------|-----------------------------|---------------|------|
|                 |                   |                   |       |       |      |       | H                           | J             | Key  |
| F89-002         | -                 | 4.76              | 2.83  | 2.91  | 2.13 | 2.60  |                             | DD 5/8 x 7/16 |      |
| F89-003         | 7.30              | 4.90              | 3.39  | 3.18  | 2.32 | 3.09  |                             | DD 5/8 x 7/16 |      |
| F89-004         | 8.53              | 5.63              | 3.78  | 3.60  | 2.40 | 3.15  |                             | DD 5/8 x 7/16 |      |
| F89-006         | 10.20             | 6.65              | 3.97  | 4.26  | 2.52 | 3.42  |                             | DD 5/8 x 7/16 |      |
| F89-009         | 10.10             | 6.85              | 4.69  | 4.87  | 2.52 | 3.91  |                             | DD 5/8 x 7/16 |      |
| F89-014         | 12.07             | 7.60              | 5.42  | 5.55  | 3.07 | 4.41  |                             | DD 5/8 x 7/16 |      |
| F89-020         | 14.89             | 9.29              | 6.10  | 6.20  | 3.19 | 4.82  |                             | DD 5/8 x 7/16 |      |
| F89-032/033     | 18.20             | 11.14             | 6.73  | 7.18  | 3.74 | 5.35  | 0.81                        | 0.84          | 0.19 |
| F89-051/052     | 18.72             | 11.73             | 8.37  | 8.25  | 4.37 | 6.26  | 0.81                        | 0.84          | 0.19 |
| F89-084/085/086 | 24.69             | 15.12             | 8.94  | 9.17  | 5.12 | 7.48  | 1.00                        | 1.06          | 0.25 |
| F89-139/140/141 | 28.58             | 16.97             | 10.79 | 11.34 | 6.06 | 9.17  | 1.00                        | 1.06          | 0.25 |
| F89-240         | 33.27             | 19.96             | 12.80 | 13.43 | 7.32 | 11.42 | 1.00                        | 1.06          | 0.25 |

## NOTES

1. A1 = spring return; A2 = double acting
2. All actuators have either DD 16.0 x 11.0 [DD 5/8 x 7/16] top shaft connection or plastic insert to this dimension, for direct mounting of AVID accessories.

# KEYSTONE F89 PNEUMATIC QUARTER-TURN ACTUATOR

## GENERAL PURPOSE / HAZARDOUS AREA

The F89 actuator is available with 4 different valve connections: F89D - ISO 5211 (metric threaded); F89E - Keystone ISO (metric threaded); F89U - Keystone imperial + metric threaded

**TABLE 3A - VALVE CONNECTION ISO FLANGE (mm)**

| Model    | F89E - Keystone ISO |                   |         |                   | F89D - ISO 5211                                |     |                   |  |
|----------|---------------------|-------------------|---------|-------------------|--|-----|-------------------|--|
|          | Bottom of shaft     |                   | Key     | PCD               | Mounting holes                                 |     | Bottom of shaft   |  |
| H        | J                   | No x Size x Depth |         |                   | Drive: Star no                                 | PCD | No x Size x Depth |  |
| F89-002  | 16.0                | 11.0              |         | F03<br>F05        | 4x M5 x 8.0<br>4x M6 x 10.0                    | 14  | F03<br>F05        | 4x M5 x 8.0<br>4x M6 x 10.0                    |
| F89-003  | 16.0                | 11.0              |         | F05<br>F07        | 4x M6 x 10.0<br>4x M8 x 13.0                   | 14  | F05<br>F07        | 4x M6 x 10.0<br>4x M8 x 13.0                   |
| F89-004  | 16.0                | 11.0              |         | F05<br>F07        | 4x M6 x 10.0<br>4x M8 x 13.0                   | 14  | F05<br>F07        | 4x M6 x 10.0<br>4x M8 x 13.0                   |
| F89-006  | 20.0                | 14.0              |         | F05<br>F07        | 4x M6 x 10.0<br>4x M8 x 13.0                   | 17  | F05<br>F07        | 4x M6 x 10.0<br>4x M8 x 13.0                   |
| F89-009  | 20.0                | 14.0              |         | F05<br>F07        | 4x M6 x 10.0<br>4x M8 x 13.0                   | 17  | F05<br>F07        | 4x M6 x 10.0<br>4x M8 x 13.0                   |
| F89-014  | 20.0                | 14.0              |         | F07               | 4x M8 x 13.0                                   | 17  | F07               | 4x M8 x 13.0                                   |
| F89-020  | 25.0                | 18.0              |         | F07<br>F10<br>F12 | 4x M8 x 13.0<br>4x M10 x 15.0<br>4x M12 x 19.0 | 22  | F07<br>F10<br>F12 | 4x M8 x 13.0<br>4x M10 x 15.0<br>4x M12 x 19.0 |
| F89-032  | 35.0                |                   | 10 x 8  | F10<br>F12        | 4x M10 x 15.0<br>4x M12 x 19.0                 | 27  | F10<br>F12        | 4x M10 x 15.0<br>4x M12 x 19.0                 |
| F89-052  | 35.0                |                   | 10 x 8  | F10<br>F12        | 4x M10 x 15.0<br>4x M12 x 19.0                 | 27  | F10<br>F12        | 4x M10 x 15.0<br>4x M12 x 19.0                 |
| F89-084* | 50.0                |                   | 14 x 9  | F10<br>F14        | 4x M10 x 15.0<br>4x M16 x 24.0                 | 36  | F10<br>F14        | 4x M10 x 15.0<br>4x M16 x 24.0                 |
| F89-085  | 50.0                |                   | 14 x 9  | F12<br>F16        | 4x M12 x 19.0<br>4x M20 x 30.0                 | 36  | F12<br>F16        | 4x M12 x 19.0<br>4x M20 x 30.0                 |
| F89-139  | 45.0                |                   | 14 x 9  | F14               | 4x M16 x 24.0                                  |     |                   |  |
| F89-140  | 50.0                |                   | 14 x 9  | F14               | 4x M16 x 24.0                                  | 46  | F14               | 4x M16 x 24.0                                  |
| F89-141  | 50.0                |                   | 14 x 9  | F12<br>F16        | 4x M12 x 19.0<br>4x M20 x 30.0                 | 46  | F12<br>F16        | 4x M12 x 19.0<br>4x M20 x 30.0                 |
| F89-240  | 70.0                |                   | 20 x 12 | F16<br>F25        | 4x M20 x 30.0<br>8x M16 x 24.0                 | 46  | F16<br>F25        | 4x M20 x 30.0<br>8x M16 x 24.0                 |

### NOTES

F89-084 is identical to F89-085 with F10-F14 flange

F89-140 is identical to F89-141 with F14 flange

\* F89-084: F10 drilling not in body; please use optional F10 to F14 conversion plate

# KEYSTONE F89 PNEUMATIC QUARTER-TURN ACTUATOR

GENERAL PURPOSE / HAZARDOUS AREA

**TABLE 3B - VALVE CONNECTION KEYSTONE FLANGE**

| Model   | F89U - Keystone metric (mm) |      |            |                |                                     | F89U - Keystone imperial (in) |      |             |                |  | Code*      |
|---------|-----------------------------|------|------------|----------------|-------------------------------------|-------------------------------|------|-------------|----------------|--|------------|
|         | Bottom of shaft             |      |            | PCD            | Mounting holes<br>No x Size x Depth | Bottom of shaft               |      |             | PCD            | Mounting holes<br>No x Size x Depth          |            |
|         | H                           | J    | Key        |                |                                     | H                             | J    | Key         |                |  |            |
| F89-002 | 15.9                        | 11.1 |            | 44.5           | 4x M6 x 10.0                        | 5/8                           | 7/16 |             | 1 3/4          | 4x 1/4-20 UNC x 0.38                         | AAA/AAC    |
| F89-003 | 19.0                        | 12.7 |            | 44.5<br>82.5   | 4x M6 x 10.0<br>4x M10 x 15.0       | 3/4                           | 1/2  |             | 1 3/4<br>3 1/4 | 4x 1/4-20 UNC x 0.38<br>4x 3/8-16 UNC x 0.56 | AAB<br>BAD |
| F89-004 | 20.6                        |      | 4.8 x 4.8  | 44.5<br>82.5   | 4x M6 x 10.0<br>4x M10 x 15.0       | 13/16                         |      | 3/16 x 3/16 | 1 3/4<br>3 1/4 | 4x 1/4-20 UNC x 0.38<br>4x 3/8-16 UNC x 0.56 | AAC<br>BAC |
| F89-006 | 25.4                        |      | 6.4 x 6.4  | 82.5           | 4x M10 x 15.0                       | 1                             |      | 1/4 x 1/4   | 3 1/4          | 4x 3/8-16 UNC x 0.56                         | BAD        |
| F89-009 | 25.4                        |      | 6.4 x 6.4  | 82.5           | 4x M10 x 15.0                       | 1                             |      | 1/4 x 1/4   | 3 1/4          | 4x 3/8-16 UNC x 0.56                         | BAD        |
| F89-014 | 25.4                        |      | 6.4 x 6.4  | 82.5           | 4x M10 x 15.0                       | 1                             |      | 1/4 x 1/4   | 3 1/4          | 4x 3/8-16 UNC x 0.56                         | BAD        |
| F89-020 | 28.6                        |      | 6.4 x 6.4  | 82.5<br>127.0  | 4x M10 x 15.0<br>4x M12 x 19.0      | 1 1/8                         |      | 1/4 x 1/4   | 3 1/4<br>5     | 4x 3/8-16 UNC x 0.56<br>4x 1/2-13 UNC x 0.63 | BAF<br>CAF |
| F89-032 | 28.6                        |      | 6.4 x 6.4  | 82.5<br>127.0  | 4x M10 x 15.0<br>4x M12 x 19.0      | 1 1/8                         |      | 1/4 x 1/4   | 3 1/4<br>5     | 4x 3/8-16 UNC x 0.56<br>4x 1/2-13 UNC x 0.63 | BAF<br>CAF |
| F89-033 | 34.9                        |      | 7.9 x 7.9  | 82.5<br>127.0  | 4x M10 x 15.0<br>4x M12 x 19.0      | 1 3/8                         |      | 5/16 x 5/16 | 3 1/4<br>5     | 4x 3/8-16 UNC x 0.56<br>4x 1/2-13 UNC x 0.63 | BAG<br>CAG |
| F89-051 | 28.6                        |      | 6.4 x 6.4  | 82.5<br>127.0  | 4x M10 x 15.0<br>4x M12 x 19.0      | 1 1/8                         |      | 1/4 x 1/4   | 3 1/4<br>5     | 4x 3/8-16 UNC x 0.56<br>4x 1/2-13 UNC x 0.63 | BAF<br>CAF |
| F89-052 | 34.9                        |      | 7.9 x 7.9  | 82.5<br>127.0  | 4x M10 x 15.0<br>4x M12 x 19.0      | 1 3/8                         |      | 5/16 x 5/16 | 3 1/4<br>5     | 4x 3/8-16 UNC x 0.56<br>4x 1/2-13 UNC x 0.63 | BAG<br>CAG |
| F89-085 | 41.3                        |      | 9.5 x 9.5  | 127.0<br>165.0 | 4x M12 x 19.0<br>4x M20 x 30.0      | 1 5/8                         |      | 3/8 x 3/8   | 5<br>6 1/2     | 4x 1/2-13 UNC x 0.63<br>4x 3/4-10 UNC x 1.00 | CAH<br>DAH |
| F89-086 | 47.6                        |      | 12.7 x 9.5 | 127.0<br>165.0 | 4x M12 x 19.0<br>4x M20 x 30.0      | 1 7/8                         |      | 1/2 x 3/8   | 5<br>6 1/2     | 4x 1/2-13 UNC x 0.63<br>4x 3/4-10 UNC x 1.00 | CAJ<br>DAJ |
| F89-140 | 57.2                        |      | 12.7 x 9.5 | 127.0<br>165.0 | 4x M12 x 19.0<br>4x M20 x 30.0      | 1 5/8                         |      | 3/8 x 3/8   | 5<br>6 1/2     | 4x 1/2-13 UNC x 0.63<br>4x 3/4-10 UNC x 1.00 | CAH<br>DAH |
| F89-141 | 57.2                        |      | 12.7 x 9.5 | 127.0<br>165.0 | 4x M12 x 19.0<br>4x M20 x 30.0      | 1 7/8                         |      | 1/2 x 3/8   | 5<br>6 1/2     | 4x 1/2-13 UNC x 0.63<br>4x 3/4-10 UNC x 1.00 | CAJ<br>DAJ |
| F89-240 | 57.2                        |      | 12.7 x 9.5 | 165.0          | 4x M20 x 30.0                       | 2 1/4                         |      | 1/2 x 3/8   | 6 1/2          | 4x 3/4-10 UNC x 1.00                         | DAK        |

**NOTES**

F89-033 is identical to F89-032 with larger bore

F89-051 is identical to F89-052 with smaller bore

F89-084 is identical to F89-085 with smaller bore

F89-141 is identical to F89-140 with larger bore

\* Keystone mounting compatibility code

# KEYSTONE F89 PNEUMATIC QUARTER-TURN ACTUATOR

## GENERAL PURPOSE / HAZARDOUS AREA

### TOP MOUNT DRILLING

The top mount drilling is available with metric or imperial threading. The dimensions of the hole pattern are identical.

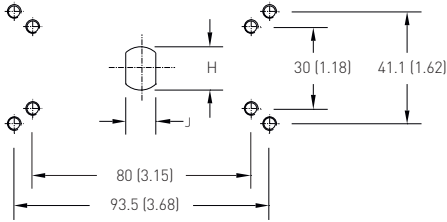

Top mounting drilling sizes 002 - 020

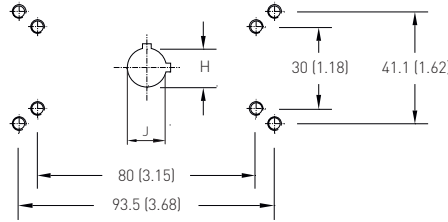

Top mounting drilling sizes 032 - 052

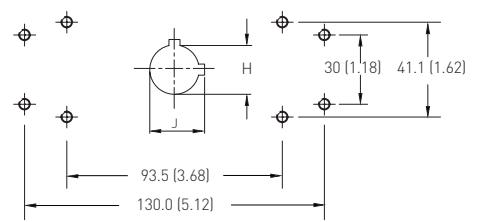

Top mounting drilling sizes 084 - 240

### NOTES

- Metric threaded versions have a bolt threading of M5x1.0 x 10.0 mm deep.
- Imperial threaded versions have a bolt threading of 10-32 UNF x 0.28 inch deep.

### NAMUR VDI/VDE 3845 MOUNTING

Full adoption to the VDI/VDE 3845 standard can be achieved with the introduction of a male insert into the female shaft.

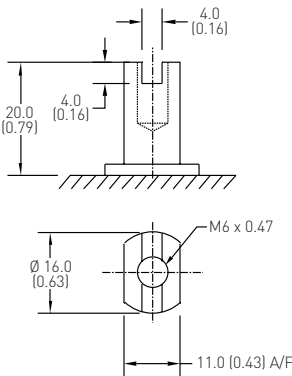

### AIR CONNECTION

The actuator is controlled by applying compressed air to the 1/4" BSP/NPT ports (3/8" BSP/NPT for Model F89-240), or with a Namur solenoid valve.

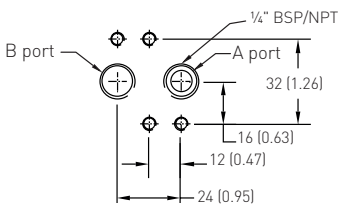

Air connection sizes 002 - 052

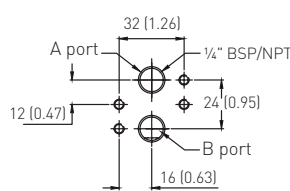

Air connection sizes 085 - 140

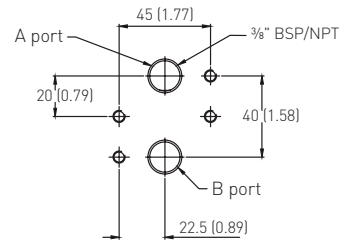

Air connection size 240

### NOTES

- Metric threaded versions have a bolt threading of M5x1.0 x 10.0 mm deep.
- Imperial threaded versions have a bolt threading of 10-32 UNF x 0.28 inch deep.

# KEYSTONE F89 PNEUMATIC QUARTER-TURN ACTUATOR

## GENERAL PURPOSE / HAZARDOUS AREA

### ACTUATOR PISTON DISPLACEMENT

Piston displacement is the total volume of pressurized air after the actuator has completed its stroke.

**TABLE 4 - ACTUATOR VOLUME**

| Model           | Opening |       | Closing |       |
|-----------------|---------|-------|---------|-------|
|                 | litres  | cu.in | litres  | cu.in |
| F89-002         | 0.11    | 6.7   | 0.09    | 5.5   |
| F89-003         | 0.17    | 10.4  | 0.14    | 8.5   |
| F89-004         | 0.25    | 15.3  | 0.21    | 12.8  |
| F89-006         | 0.36    | 21.8  | 0.29    | 17.7  |
| F89-009         | 0.57    | 34.9  | 0.48    | 29.3  |
| F89-014         | 0.90    | 54.9  | 0.73    | 44.5  |
| F89-020         | 1.37    | 83.8  | 1.08    | 65.9  |
| F89-032/033     | 2.10    | 128.2 | 1.66    | 101.3 |
| F89-051/052     | 3.10    | 189.2 | 2.63    | 160.5 |
| F89-084/085/086 | 5.09    | 310.6 | 3.87    | 236.2 |
| F89-139/140/141 | 8.92    | 544.3 | 6.81    | 415.6 |
| F89-240         | 15.40   | 939.8 | 12.63   | 770.7 |

**TABLE 5 - ACTUATOR CYCLING TIME (s)**

| Model           | DA          |         |            |         | SR          |         |            |         |
|-----------------|-------------|---------|------------|---------|-------------|---------|------------|---------|
|                 | Travel time |         | Total time |         | Travel time |         | Total time |         |
|                 | Opening     | Closing | Opening    | Closing | Opening     | Closing | Opening    | Closing |
| F89-002         | 0.1         | 0.0     | 0.1        | 0.0     |             |         |            |         |
| F89-003         | 0.1         | 0.1     | 0.1        | 0.1     | 0.8         | 0.8     | 1.5        | 1.5     |
| F89-004         | 0.1         | 0.1     | 0.1        | 0.1     | 0.9         | 0.9     | 1.8        | 1.8     |
| F89-006         | 0.1         | 0.1     | 0.1        | 0.1     | 1.1         | 1.1     | 2.1        | 2.1     |
| F89-009         | 0.2         | 0.2     | 0.2        | 0.2     | 1.2         | 1.2     | 2.4        | 2.4     |
| F89-014         | 0.3         | 0.2     | 0.3        | 0.3     | 1.4         | 1.4     | 2.7        | 2.7     |
| F89-020         | 0.4         | 0.3     | 0.5        | 0.4     | 1.5         | 1.5     | 3.0        | 3.0     |
| F89-032/033     | 0.5         | 0.5     | 0.7        | 0.6     | 2.3         | 2.3     | 4.5        | 4.5     |
| F89-051/052     | 0.8         | 0.7     | 1.1        | 0.9     | 3.0         | 3.0     | 6.0        | 6.0     |
| F89-084/085/086 | 1.2         | 0.8     | 1.8        | 1.0     |             |         |            |         |
| F89-139/140/141 | 2.3         | 2.2     | 3.2        | 2.3     |             |         |            |         |
| F89-240         | 3.2         | 3.1     | 5.5        | 4.3     |             |         |            |         |

### NOTES

1. The actuator cycling time consist of a time required to build up the pressure and secondly move the pistons and valve (travel time). The sum of these values is the total cycling time.
2. The actuator cycle time varies with the supplied air pressure, solenoid valve, and required valve torque, and are for indication only.
3. Indicated times above are based on bare actuator using 5.5 bar (80 psi) air pressure and a solenoid valve with  $C_v$  of 1300 l/m (46 CFM).

**TABLE 6 - ACTUATOR WEIGHT**

| Model           | DA   |       | SR    |       |
|-----------------|------|-------|-------|-------|
|                 | kg   | lbs   | kg    | lbs   |
| F89-002         | 1.0  | 2.2   | -     | -     |
| F89-003         | 1.4  | 3.1   | 1.7   | 3.7   |
| F89-004         | 2.1  | 4.6   | 2.6   | 5.7   |
| F89-006         | 2.9  | 6.4   | 3.6   | 7.9   |
| F89-009         | 3.7  | 8.2   | 4.9   | 10.8  |
| F89-014         | 5.3  | 11.7  | 7.3   | 16.1  |
| F89-020         | 7.9  | 17.4  | 11.0  | 24.3  |
| F89-032/033     | 12.1 | 26.7  | 16.7  | 36.8  |
| F89-051/052     | 18.3 | 40.3  | 24.9  | 54.9  |
| F89-084/085/086 | 27.8 | 61.3  | 39.7  | 87.5  |
| F89-139/140/141 | 45.8 | 101.0 | 69.5  | 153.2 |
| F89-240         | 77.5 | 170.9 | 112.4 | 247.8 |



# KEYSTONE F89 PNEUMATIC QUARTER-TURN ACTUATOR

GENERAL PURPOSE / HAZARDOUS AREA

## MATERIALS OF CONSTRUCTION

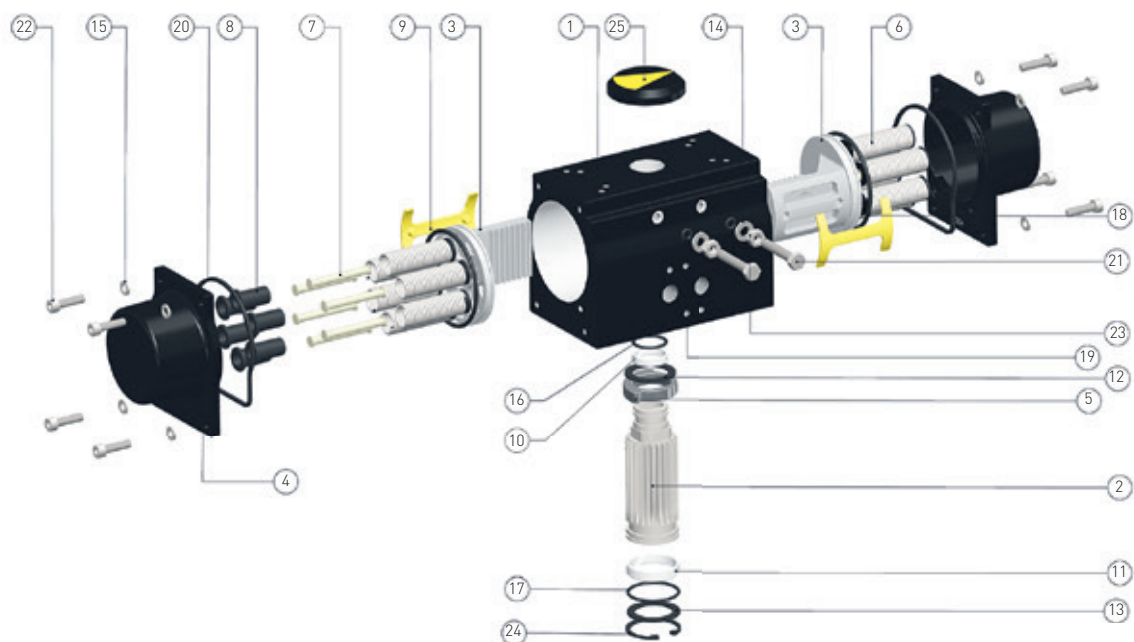

**TABLE 7 - MATERIALS OF CONSTRUCTION**

| No. | Item                           | Material  | US material std | BS material std | DIN material std     | Finish                                       |
|-----|--------------------------------|---|-----------------|-----------------|----------------------|--|
| 1   | Body                           | Extruded aluminium<br>ASTM B221 type 6063T6                           | ASTM B221       | BS 1474 6063    | DIN 3.33206.51       | Anodized 5-8 microns +<br>ESPC 60-80 microns |
| 2   | Pinion                         | Hot rolled carbon steel bar<br>ASTM A108 grade 1045                   | A108            | BS 970 080M40   | C40                  | Zink-Nickel plated<br>8-12 microns           |
| 3   | Piston                         | Die cast aluminium alloy<br>ASTM B85 type A380 /BS 1490<br>grade LM24 | ASTM B85        | BS 1490         | DIN 1725-2300 or 226 | Anodized                                     |
| 4   | End cap                        | Die cast aluminium alloy<br>ASTM B85 type A380/BS 1490<br>grade LM24  | ASTM B85        | BS 1490         | DIN 1725-2300 or 226 | ESPC 60-80 microns                           |
| 5   | Cam                            | Cast grade SAE 1045/C45 / EN8   |                 |                 |                      | Blackodised                                  |
| 6   | Spring                         | Spring steel as per ASTM A401   | ASTM A401       | BS 5216 HS3     | DIN 17223 PtI        | Epoxy coated 30-40 microns                   |
| 7   | Spring retainer                | Carbon steel  |                 |                 |                      | Zinc plated                                  |
| 8   | Spring cup                     | Die cast aluminium alloy<br>ASTM B85 type A380 /BS 1490<br>grade LM24 | ASTM B85        | BS 1490         | DIN1725-2300 or 226  | Anodized                                     |
| 9   | Piston guide                   | Zytel 101F NC010  |                 |                 |                      | Natural                                      |
| 10  | Top bearing                    | PAR <sup>(1)</sup> + 25% glass filled                                 |                 |                 |                      | Natural                                      |
| 11  | Bottom bearing                 | PAR <sup>(1)</sup> + 25% glass filled                                 |                 |                 |                      | Natural                                      |
| 12  | Top thrust washer              | PA66 <sup>(2)</sup>   |                 |                 |                      | Natural                                      |
| 13  | Bottom thrust washer           | PA66 <sup>(2)</sup>   |                 |                 |                      | Natural                                      |
| 14  | Travel stop washer             | SS <sup>(3)</sup> ISO 3506 A2-70 grade                                |                 |                 |                      | Natural                                      |
| 15  | End cap washer (spring washer) | SS <sup>(3)</sup> ISO 3506 A2-70 grade                                |                 |                 |                      | Natural                                      |
| 16  | Top O-ring (pinion)            | NBR shore 70 A  |                 |                 |                      | Natural                                      |
| 17  | Bottom O-ring (pinion)         | NBR shore 70 A  |                 |                 |                      | Natural                                      |
| 18  | O-ring (piston)                | NBR shore 70 A  |                 |                 |                      | Natural                                      |
| 19  | O-ring (travel stop)           | NBR shore 70 A  |                 |                 |                      | Natural                                      |
| 20  | Gasket (end cap)               | NBR shore 70 A  |                 |                 |                      | Natural                                      |
| 21  | Bolt - travel stop             | SS <sup>(3)</sup> ISO 3506 A2-70 grade                                |                 |                 |                      | Natural                                      |
| 22  | Bolt - end cap                 | SS <sup>(3)</sup> ISO 3506 A2-70 grade                                |                 |                 |                      | Natural                                      |
| 23  | Nut - travel stop              | SS <sup>(3)</sup> ISO 3506 A2-70 grade                                |                 |                 |                      | Natural                                      |
| 24  | Circlip (bottom)               | Carbon steel  |                 |                 |                      | Zink-Nickel plated                           |
| 25  | Position indicator             | ABS plastic   |                 |                 |                      | Natural                                      |

1. POM Acetal Resin

2. Polyamide grade 66

3. Stainless steel

# KEYSTONE F89 PNEUMATIC QUARTER-TURN ACTUATOR

## GENERAL PURPOSE / HAZARDOUS AREA

### TORQUE OUTPUT

#### Double acting actuator

For sizing of double acting actuators use the following table and select the actuator which will provide nearest torque output above the anticipated torque of the valve and required safety factor.

**TABLE 8 - DA TORQUE (Nm)**

| Model       | Air pressure (bar) |      |      |      |      |      |      |
|-------------|--------------------|------|------|------|------|------|------|
|             | 3                  | 4    | 5    | 5.5  | 6    | 7    | 8.3  |
| F89-002     | 11                 | 15   | 19   | 21   | 23   | 26   | 31   |
| F89-003     | 17                 | 22   | 28   | 31   | 33   | 39   | 46   |
| F89-004     | 25                 | 34   | 42   | 46   | 50   | 59   | 70   |
| F89-006     | 36                 | 48   | 60   | 66   | 72   | 84   | 100  |
| F89-009     | 58                 | 77   | 96   | 106  | 116  | 135  | 160  |
| F89-014     | 90                 | 121  | 151  | 166  | 181  | 211  | 250  |
| F89-020     | 132                | 177  | 221  | 243  | 265  | 309  | 366  |
| F89-032/033 | 208                | 277  | 346  | 381  | 416  | 485  | 575  |
| F89-051/052 | 315                | 420  | 525  | 577  | 630  | 735  | 871  |
| F89-084/085 | 525                | 700  | 875  | 963  | 1051 | 1226 | 1453 |
| F89-140/141 | 875                | 1167 | 1458 | 1604 | 1750 | 2041 | 2421 |
| F89-240     | 1508               | 2011 | 2514 | 2765 | 3016 | 3519 | 4173 |

**TABLE 9 - DA TORQUE (in-lb)**

| Model       | Air pressure (psi) |       |       |       |       |       |       |
|-------------|--------------------|-------|-------|-------|-------|-------|-------|
|             | 40                 | 60    | 70    | 80    | 90    | 100   | 120   |
| F89-002     | 100                | 134   | 167   | 184   | 201   | 234   | 277   |
| F89-003     | 147                | 197   | 246   | 270   | 295   | 344   | 408   |
| F89-004     | 223                | 297   | 372   | 409   | 446   | 521   | 617   |
| F89-006     | 320                | 427   | 534   | 587   | 641   | 747   | 886   |
| F89-009     | 512                | 683   | 853   | 938   | 1024  | 1194  | 1416  |
| F89-014     | 801                | 1068  | 1334  | 1468  | 1601  | 1868  | 2215  |
| F89-020     | 1173               | 1563  | 1954  | 2150  | 2345  | 2736  | 3244  |
| F89-032/033 | 1841               | 2455  | 3068  | 3375  | 3682  | 4295  | 5093  |
| F89-051/052 | 2789               | 3718  | 4648  | 5112  | 5577  | 6507  | 7715  |
| F89-084/085 | 4652               | 6203  | 7754  | 8529  | 9304  | 10855 | 12871 |
| F89-140/141 | 7749               | 10332 | 12915 | 14206 | 15497 | 18080 | 21438 |
| F89-240     | 13357              | 17810 | 22262 | 24489 | 26715 | 31167 | 36955 |

#### Spring return actuator

Sizing of spring return actuators is more complex. First you need to determine the desired 'failure mode' (fail open or fail closed). Secondly you need to determine the critical torque points for the subject valve using the table below.

| Butterfly valves 'fail closed' | Butterfly valves 'fail open' |
|--------------------------------|------------------------------|
| Start of air torque            | Start of spring torque       |
| End of spring torque           | End of air torque            |

| Ball valves 'fail closed'                   | Ball valves 'fail open'                  |
|---|--|
| Start of air (unseating) torque             | Start of spring (unseating) torque       |
| End of air (full open) torque               | End of spring (full open) torque         |
| Start of spring (breakout from open) torque | Start of air (breakout from open) torque |
| End of spring (re-seating) torque           | End of air (re-seating) torque           |

# KEYSTONE F89 PNEUMATIC QUARTER-TURN ACTUATOR

GENERAL PURPOSE / HAZARDOUS AREA

**TABLE 10 - SR TORQUE (Nm)**

| Model   | Number of springs | Air pressure (bar) |     |     |     |     |     |     |     |     |     |     |     |     |     | Spring torque |     |    |
|---------|-------------------|--------------------|-----|-----|-----|-----|-----|-----|-----|-----|-----|-----|-----|-----|-----|---------------|-----|----|
|         |                   | 3                  |     | 4   |     | 5   |     | 5.5 |     | 6   |     | 7   |     | 8.3 |     | SST           | SET |    |
|         |                   | AST                | AET | AST | AET | AST | AET | AST | AET | AST | AET | AST | AET | AST | AET |               |     |    |
| F89-003 | 4                 | 11                 | 8   | 16  | 13  | 22  | 19  | 25  | 22  | 28  | 24  | 33  | 30  | 40  | 37  | 9             | 6   |    |
|         | 5                 | 9                  | 6   | 15  | 11  | 21  | 17  | 23  | 19  | 26  | 22  | 32  | 28  | 39  | 35  | 11            | 7   |    |
|         | 6                 | 8                  | 3   | 14  | 9   | 19  | 14  | 22  | 17  | 25  | 20  | 30  | 26  | 37  | 33  | 13            | 9   |    |
|         | 7                 | 7                  | 1   | 12  | 7   | 18  | 12  | 20  | 15  | 23  | 18  | 29  | 23  | 36  | 31  | 16            | 10  |    |
|         | 8                 |                    |     | 11  | 4   | 16  | 10  | 19  | 13  | 22  | 16  | 27  | 21  | 34  | 28  | 18            | 12  |    |
|         | 9                 |                    |     | 9   | 2   | 15  | 8   | 17  | 11  | 20  | 13  | 26  | 19  | 33  | 26  | 20            | 13  |    |
|         | 10                |                    |     |     |     | 13  | 6   | 16  | 8   | 19  | 11  | 24  | 17  | 32  | 24  | 22            | 15  |    |
|         | 11                |                    |     |     |     | 12  | 3   | 15  | 6   | 17  | 9   | 23  | 14  | 30  | 22  | 24            | 16  |    |
|         | 12                |                    |     |     |     |     |     | 13  | 4   | 16  | 7   | 21  | 12  | 29  | 19  | 27            | 17  |    |
|         | F89-004           | 4                  | 17  | 12  | 25  | 21  | 33  | 29  | 38  | 33  | 42  | 37  | 50  | 46  | 61  | 57            | 13  | 9  |
|         |                   | 5                  | 15  | 9   | 23  | 17  | 31  | 26  | 36  | 30  | 40  | 34  | 48  | 43  | 59  | 53            | 16  | 11 |
|         |                   | 6                  | 12  | 6   | 21  | 14  | 29  | 23  | 33  | 27  | 38  | 31  | 46  | 39  | 57  | 50            | 19  | 13 |
| 7       |                   | 10                 | 3   | 19  | 11  | 27  | 19  | 31  | 23  | 35  | 28  | 44  | 36  | 55  | 47  | 23            | 15  |    |
| 8       |                   |                    |     | 17  | 8   | 25  | 16  | 29  | 20  | 33  | 24  | 42  | 33  | 53  | 44  | 26            | 17  |    |
| 9       |                   |                    |     | 14  | 4   | 23  | 13  | 27  | 17  | 31  | 21  | 40  | 30  | 50  | 41  | 29            | 19  |    |
| 10      |                   |                    |     |     |     | 21  | 10  | 25  | 14  | 29  | 18  | 37  | 26  | 48  | 37  | 32            | 21  |    |
| 11      |                   |                    |     |     |     | 19  | 6   | 23  | 11  | 27  | 15  | 35  | 23  | 46  | 34  | 36            | 23  |    |
| 12      |                   |                    |     |     |     |     |     | 21  | 7   | 25  | 11  | 33  | 20  | 44  | 31  | 39            | 26  |    |
| F89-006 |                   | 4                  | 24  | 13  | 36  | 25  | 48  | 37  | 54  | 43  | 60  | 49  | 72  | 61  | 88  | 77            | 23  | 12 |
|         |                   | 5                  | 21  | 7   | 33  | 19  | 45  | 31  | 51  | 37  | 57  | 43  | 69  | 55  | 85  | 71            | 29  | 15 |
|         |                   | 6                  | 18  | 2   | 30  | 14  | 42  | 26  | 48  | 32  | 54  | 38  | 66  | 50  | 82  | 65            | 34  | 18 |
|         | 7                 |                    |     | 27  | 8   | 39  | 20  | 45  | 26  | 51  | 32  | 63  | 44  | 79  | 60  | 40            | 21  |    |
|         | 8                 |                    |     | 24  | 2   | 36  | 14  | 42  | 20  | 48  | 26  | 60  | 38  | 76  | 54  | 46            | 24  |    |
|         | 9                 |                    |     |     |     | 33  | 9   | 39  | 15  | 45  | 21  | 57  | 33  | 73  | 48  | 51            | 27  |    |
|         | 10                |                    |     |     |     | 30  | 3   | 36  | 9   | 42  | 15  | 54  | 27  | 70  | 43  | 57            | 30  |    |
|         | 11                |                    |     |     |     |     |     | 33  | 3   | 39  | 9   | 51  | 21  | 67  | 37  | 63            | 33  |    |
|         | 12                |                    |     |     |     |     |     |     |     | 37  | 4   | 49  | 16  | 64  | 31  | 69            | 36  |    |
|         | F89-009           | 4                  | 38  | 29  | 58  | 48  | 77  | 67  | 87  | 77  | 96  | 86  | 115 | 106 | 140 | 131           | 29  | 19 |
|         |                   | 5                  | 33  | 21  | 53  | 41  | 72  | 60  | 82  | 70  | 91  | 79  | 111 | 98  | 136 | 123           | 36  | 24 |
|         |                   | 6                  | 29  | 14  | 48  | 33  | 67  | 53  | 77  | 62  | 86  | 72  | 106 | 91  | 131 | 116           | 44  | 29 |
| 7       |                   | 24                 | 7   | 43  | 26  | 62  | 45  | 72  | 55  | 82  | 65  | 101 | 84  | 126 | 109 | 51            | 34  |    |
| 8       |                   |                    |     | 38  | 19  | 57  | 38  | 67  | 48  | 77  | 57  | 96  | 77  | 121 | 102 | 58            | 39  |    |
| 9       |                   |                    |     | 33  | 11  | 53  | 31  | 62  | 40  | 72  | 50  | 91  | 69  | 116 | 94  | 66            | 44  |    |
| 10      |                   |                    |     |     |     | 48  | 23  | 57  | 33  | 67  | 43  | 86  | 62  | 111 | 87  | 73            | 49  |    |
| 11      |                   |                    |     |     |     | 43  | 16  | 52  | 26  | 62  | 35  | 81  | 55  | 106 | 80  | 80            | 53  |    |
| 12      |                   |                    |     |     |     |     |     | 48  | 18  | 57  | 28  | 77  | 47  | 102 | 72  | 88            | 58  |    |
| F89-014 |                   | 4                  | 60  | 46  | 91  | 76  | 121 | 106 | 136 | 121 | 151 | 136 | 181 | 166 | 220 | 205           | 45  | 30 |
|         |                   | 5                  | 53  | 35  | 83  | 65  | 113 | 95  | 128 | 110 | 143 | 125 | 173 | 155 | 213 | 194           | 56  | 38 |
|         |                   | 6                  | 45  | 23  | 75  | 53  | 106 | 84  | 121 | 99  | 136 | 114 | 166 | 144 | 205 | 183           | 67  | 45 |
|         | 7                 | 38                 | 12  | 68  | 42  | 98  | 72  | 113 | 88  | 128 | 103 | 158 | 133 | 198 | 172 | 78            | 53  |    |
|         | 8                 |                    |     | 60  | 31  | 91  | 61  | 106 | 76  | 121 | 91  | 151 | 122 | 190 | 161 | 89            | 60  |    |
|         | 9                 |                    |     | 53  | 20  | 83  | 50  | 98  | 65  | 113 | 80  | 143 | 110 | 183 | 150 | 101           | 68  |    |
|         | 10                |                    |     |     |     | 76  | 39  | 91  | 54  | 106 | 69  | 136 | 99  | 175 | 138 | 112           | 75  |    |
|         | 11                |                    |     |     |     | 68  | 28  | 83  | 43  | 98  | 58  | 128 | 88  | 168 | 127 | 123           | 83  |    |
|         | 12                |                    |     |     |     |     |     | 76  | 32  | 91  | 47  | 121 | 77  | 160 | 116 | 134           | 90  |    |
|         | F89-020           | 4                  | 86  | 62  | 130 | 107 | 174 | 151 | 196 | 173 | 218 | 195 | 262 | 239 | 320 | 296           | 70  | 47 |
|         |                   | 5                  | 74  | 45  | 118 | 89  | 162 | 133 | 184 | 155 | 206 | 177 | 251 | 221 | 308 | 279           | 88  | 58 |
|         |                   | 6                  | 62  | 27  | 107 | 72  | 151 | 116 | 173 | 138 | 195 | 160 | 239 | 204 | 296 | 261           | 105 | 70 |
| 7       |                   | 51                 | 10  | 95  | 54  | 139 | 98  | 161 | 120 | 183 | 142 | 227 | 186 | 285 | 244 | 123           | 82  |    |
| 8       |                   |                    |     | 83  | 37  | 127 | 81  | 149 | 103 | 171 | 125 | 216 | 169 | 273 | 226 | 140           | 93  |    |
| 9       |                   |                    |     | 72  | 19  | 116 | 63  | 138 | 85  | 160 | 107 | 204 | 151 | 261 | 209 | 158           | 105 |    |
| 10      |                   |                    |     |     |     | 104 | 46  | 126 | 68  | 148 | 90  | 192 | 134 | 250 | 191 | 175           | 117 |    |
| 11      |                   |                    |     |     |     | 92  | 28  | 114 | 50  | 136 | 72  | 181 | 116 | 238 | 174 | 193           | 128 |    |
| 12      |                   |                    |     |     |     |     |     | 103 | 33  | 125 | 55  | 169 | 99  | 226 | 156 | 210           | 140 |    |

# KEYSTONE F89 PNEUMATIC QUARTER-TURN ACTUATOR

GENERAL PURPOSE / HAZARDOUS AREA

TABLE 10 - SR TORQUE (Nm) continued

| Model       | Number of springs | Air pressure (bar) |     |      |      |      |      |      |      |      |      |      |      |      |      | Spring torque |      |     |
|-------------|-------------------|--------------------|-----|------|------|------|------|------|------|------|------|------|------|------|------|---------------|------|-----|
|             |                   | 3                  |     | 4    |      | 5    |      | 5.5  |      | 6    |      | 7    |      | 8.3  |      | SST           | SET  |     |
|             |                   | AST                | AET | AST  | AET  | AST  | AET  | AST  | AET  | AST  | AET  | AST  | AET  | AST  | AET  |               |      |     |
| F89-032/033 | 4                 | 134                | 96  | 203  | 166  | 272  | 235  | 307  | 270  | 341  | 304  | 411  | 374  | 501  | 464  | 111           | 74   |     |
|             | 5                 | 115                | 69  | 184  | 138  | 254  | 207  | 288  | 242  | 323  | 276  | 392  | 346  | 482  | 436  | 139           | 93   |     |
|             | 6                 | 96                 | 41  | 166  | 110  | 235  | 179  | 270  | 214  | 304  | 249  | 374  | 318  | 464  | 408  | 167           | 111  |     |
|             | 7                 | 78                 | 13  | 147  | 82   | 216  | 151  | 251  | 186  | 286  | 221  | 355  | 290  | 445  | 380  | 195           | 130  |     |
|             | 8                 |                    |     | 129  | 54   | 198  | 124  | 232  | 158  | 267  | 193  | 336  | 262  | 426  | 352  | 223           | 149  |     |
|             | 9                 |                    |     | 110  | 26   | 179  | 96   | 214  | 130  | 249  | 165  | 318  | 234  | 408  | 324  | 251           | 167  |     |
|             | 10                |                    |     |      |      | 161  | 68   | 195  | 102  | 230  | 137  | 299  | 206  | 389  | 296  | 279           | 186  |     |
|             | 11                |                    |     |      |      | 142  | 40   | 177  | 75   | 211  | 109  | 281  | 178  | 371  | 269  | 307           | 204  |     |
|             | 12                |                    |     |      |      |      |      | 158  | 47   | 193  | 81   | 262  | 151  | 352  | 241  | 334           | 223  |     |
|             | F89-051/052       | 4                  | 195 | 135  | 300  | 240  | 405  | 345  | 457  | 398  | 510  | 450  | 615  | 555  | 751  | 691           | 180  | 120 |
|             |                   | 5                  | 165 | 90   | 270  | 195  | 375  | 300  | 428  | 353  | 480  | 405  | 585  | 510  | 721  | 647           | 225  | 150 |
|             |                   | 6                  | 135 | 45   | 240  | 150  | 345  | 255  | 398  | 308  | 450  | 360  | 555  | 465  | 691  | 602           | 269  | 180 |
| 7           |                   | 105                | 1   | 210  | 105  | 315  | 210  | 368  | 263  | 420  | 315  | 525  | 420  | 662  | 557  | 314           | 210  |     |
| 8           |                   |                    |     | 180  | 61   | 285  | 166  | 338  | 218  | 390  | 270  | 495  | 375  | 632  | 512  | 359           | 240  |     |
| 9           |                   |                    |     | 150  | 16   | 255  | 121  | 308  | 173  | 360  | 226  | 465  | 331  | 602  | 467  | 404           | 269  |     |
| 10          |                   |                    |     |      |      | 225  | 76   | 278  | 128  | 330  | 181  | 435  | 286  | 572  | 422  | 449           | 299  |     |
| 11          |                   |                    |     |      |      | 195  | 31   | 248  | 83   | 300  | 136  | 405  | 241  | 542  | 377  | 494           | 329  |     |
| 12          |                   |                    |     |      |      |      |      | 218  | 38   | 270  | 91   | 375  | 196  | 512  | 332  | 539           | 359  |     |
| F89-084/085 |                   | 4                  | 329 | 231  | 504  | 406  | 679  | 581  | 767  | 669  | 855  | 757  | 1030 | 932  | 1257 | 1159          | 294  | 196 |
|             |                   | 5                  | 280 | 157  | 455  | 332  | 630  | 507  | 718  | 595  | 806  | 683  | 981  | 858  | 1208 | 1085          | 368  | 245 |
|             |                   | 6                  | 231 | 83   | 406  | 258  | 581  | 433  | 669  | 521  | 757  | 609  | 932  | 784  | 1159 | 1011          | 442  | 294 |
|             | 7                 | 181                | 10  | 356  | 185  | 531  | 360  | 619  | 448  | 707  | 536  | 882  | 711  | 1109 | 938  | 515           | 344  |     |
|             | 8                 |                    |     | 307  | 111  | 482  | 286  | 570  | 374  | 658  | 462  | 833  | 637  | 1060 | 864  | 589           | 393  |     |
|             | 9                 |                    |     | 258  | 37   | 433  | 212  | 521  | 300  | 609  | 388  | 784  | 563  | 1011 | 790  | 663           | 442  |     |
|             | 10                |                    |     |      |      | 384  | 139  | 472  | 227  | 560  | 315  | 735  | 490  | 962  | 717  | 736           | 491  |     |
|             | 11                |                    |     |      |      | 335  | 65   | 423  | 153  | 511  | 241  | 686  | 416  | 913  | 643  | 810           | 540  |     |
|             | 12                |                    |     |      |      |      |      | 374  | 80   | 462  | 168  | 637  | 343  | 864  | 570  | 883           | 589  |     |
|             | F89-139/140/141   | 4                  | 548 | 384  | 840  | 676  | 1131 | 967  | 1277 | 1113 | 1423 | 1259 | 1714 | 1550 | 2094 | 1930          | 491  | 327 |
|             |                   | 5                  | 466 | 262  | 758  | 554  | 1049 | 845  | 1195 | 991  | 1341 | 1137 | 1632 | 1428 | 2012 | 1808          | 613  | 409 |
|             |                   | 6                  | 384 | 139  | 676  | 431  | 967  | 722  | 1113 | 868  | 1259 | 1014 | 1550 | 1305 | 1930 | 1685          | 736  | 491 |
| 7           |                   | 303                | 16  | 595  | 308  | 886  | 599  | 1032 | 745  | 1178 | 891  | 1469 | 1182 | 1849 | 1562 | 859           | 572  |     |
| 8           |                   |                    |     | 513  | 186  | 804  | 477  | 950  | 623  | 1096 | 769  | 1387 | 1060 | 1767 | 1440 | 981           | 654  |     |
| 9           |                   |                    |     | 431  | 63   | 722  | 354  | 868  | 500  | 1014 | 646  | 1305 | 937  | 1685 | 1317 | 1104          | 736  |     |
| 10          |                   |                    |     |      |      | 640  | 231  | 786  | 377  | 932  | 523  | 1223 | 814  | 1603 | 1194 | 1227          | 818  |     |
| 11          |                   |                    |     |      |      | 558  | 109  | 704  | 255  | 850  | 401  | 1141 | 692  | 1521 | 1072 | 1349          | 900  |     |
| 12          |                   |                    |     |      |      |      |      | 623  | 132  | 769  | 278  | 1060 | 569  | 1440 | 949  | 1472          | 981  |     |
| F89-240     |                   | 4                  | 954 | 676  | 1457 | 1179 | 1960 | 1682 | 2211 | 1933 | 2462 | 2184 | 2965 | 2687 | 3619 | 3341          | 832  | 554 |
|             |                   | 5                  | 815 | 469  | 1318 | 972  | 1821 | 1475 | 2072 | 1726 | 2323 | 1977 | 2826 | 2480 | 3480 | 3134          | 1039 | 693 |
|             |                   | 6                  | 676 | 261  | 1179 | 764  | 1682 | 1267 | 1933 | 1518 | 2184 | 1769 | 2687 | 2272 | 3341 | 2926          | 1247 | 832 |
|             | 7                 | 538                | 53  | 1041 | 556  | 1544 | 1059 | 1795 | 1310 | 2046 | 1561 | 2549 | 2064 | 3203 | 2718 | 1455          | 970  |     |
|             | 8                 |                    |     | 902  | 348  | 1405 | 851  | 1656 | 1102 | 1907 | 1353 | 2410 | 1856 | 3064 | 2510 | 1663          | 1109 |     |
|             | 9                 |                    |     | 764  | 140  | 1267 | 643  | 1518 | 894  | 1769 | 1145 | 2272 | 1648 | 2926 | 2302 | 1871          | 1247 |     |
|             | 10                |                    |     |      |      | 1128 | 435  | 1379 | 686  | 1630 | 937  | 2133 | 1440 | 2787 | 2094 | 2079          | 1386 |     |
|             | 11                |                    |     |      |      | 990  | 227  | 1241 | 478  | 1492 | 729  | 1995 | 1232 | 2649 | 1886 | 2287          | 1524 |     |
|             | 12                |                    |     |      |      |      |      | 1102 | 270  | 1353 | 521  | 1856 | 1024 | 2510 | 1678 | 2495          | 1663 |     |

# KEYSTONE F89 PNEUMATIC QUARTER-TURN ACTUATOR

GENERAL PURPOSE / HAZARDOUS AREA

**TABLE 11 - SR TORQUE (in-lb)**

| Model   | Number of springs | Air pressure (psi) |     |      |     |      |      |      |      |      |      |      |      |      |      | Spring torque |      |
|---------|-------------------|--------------------|-----|------|-----|------|------|------|------|------|------|------|------|------|------|---------------|------|
|         |                   | 40                 |     | 60   |     | 70   |      | 80   |      | 90   |      | 100  |      | 120  |      | SST           | SET  |
|         |                   | AST                | AET | AST  | AET | AST  | AET  | AST  | AET  | AST  | AET  | AST  | AET  | AST  | AET  |               |      |
| F89-003 | 4                 | 97                 | 71  | 142  | 115 | 195  | 168  | 221  | 195  | 248  | 213  | 292  | 266  | 354  | 328  | 80            | 53   |
|         | 5                 | 80                 | 53  | 133  | 97  | 186  | 151  | 204  | 168  | 230  | 195  | 283  | 248  | 345  | 310  | 97            | 62   |
|         | 6                 | 70                 | 30  | 120  | 79  | 169  | 128  | 193  | 153  | 218  | 177  | 267  | 226  | 331  | 290  | 118           | 77   |
|         | 7                 | 58                 | 10  | 107  | 59  | 156  | 108  | 180  | 133  | 205  | 157  | 254  | 207  | 318  | 270  | 137           | 90   |
|         | 8                 |                    |     | 94   | 39  | 143  | 89   | 168  | 113  | 192  | 138  | 241  | 187  | 305  | 251  | 157           | 103  |
|         | 9                 |                    |     | 81   | 20  | 130  | 69   | 155  | 94   | 179  | 118  | 229  | 167  | 292  | 231  | 177           | 116  |
|         | 10                |                    |     |      |     | 117  | 49   | 142  | 74   | 167  | 99   | 216  | 148  | 280  | 212  | 196           | 128  |
|         | 11                |                    |     |      |     | 105  | 30   | 129  | 54   | 154  | 79   | 203  | 128  | 267  | 192  | 216           | 141  |
|         | 12                |                    |     |      |     |      |      | 116  | 35   | 141  | 59   | 190  | 108  | 254  | 172  | 236           | 154  |
| F89-004 | 4                 | 151                | 106 | 221  | 186 | 292  | 257  | 337  | 292  | 372  | 328  | 443  | 407  | 540  | 505  | 115           | 80   |
|         | 5                 | 133                | 80  | 204  | 151 | 275  | 230  | 319  | 266  | 354  | 301  | 425  | 381  | 523  | 469  | 142           | 97   |
|         | 6                 | 110                | 51  | 184  | 125 | 259  | 200  | 296  | 237  | 333  | 274  | 407  | 348  | 504  | 445  | 172           | 113  |
|         | 7                 | 91                 | 22  | 165  | 97  | 240  | 171  | 277  | 208  | 314  | 245  | 388  | 320  | 485  | 416  | 201           | 132  |
|         | 8                 |                    |     | 146  | 68  | 221  | 142  | 258  | 179  | 295  | 217  | 369  | 291  | 466  | 388  | 230           | 151  |
|         | 9                 |                    |     | 127  | 39  | 202  | 113  | 239  | 151  | 276  | 188  | 351  | 262  | 447  | 359  | 258           | 170  |
|         | 10                |                    |     |      |     | 183  | 85   | 220  | 122  | 257  | 159  | 332  | 233  | 428  | 330  | 287           | 189  |
|         | 11                |                    |     |      |     | 164  | 56   | 201  | 93   | 238  | 130  | 313  | 205  | 409  | 301  | 316           | 208  |
|         | 12                |                    |     |      |     |      |      | 182  | 65   | 220  | 102  | 294  | 176  | 391  | 273  | 344           | 227  |
| F89-006 | 4                 | 214                | 117 | 320  | 223 | 426  | 329  | 479  | 382  | 533  | 435  | 639  | 541  | 777  | 679  | 202           | 105  |
|         | 5                 | 188                | 66  | 294  | 172 | 400  | 278  | 453  | 332  | 506  | 385  | 613  | 491  | 751  | 629  | 253           | 131  |
|         | 6                 | 162                | 15  | 268  | 122 | 374  | 228  | 427  | 281  | 480  | 334  | 586  | 440  | 724  | 578  | 303           | 157  |
|         | 7                 |                    |     | 242  | 71  | 348  | 177  | 401  | 230  | 454  | 284  | 560  | 390  | 698  | 528  | 354           | 183  |
|         | 8                 |                    |     | 215  | 21  | 322  | 127  | 375  | 180  | 428  | 233  | 534  | 339  | 672  | 477  | 404           | 210  |
|         | 9                 |                    |     |      |     | 295  | 76   | 348  | 129  | 402  | 183  | 508  | 289  | 646  | 427  | 455           | 236  |
|         | 10                |                    |     |      |     | 269  | 26   | 322  | 79   | 375  | 132  | 482  | 238  | 620  | 376  | 505           | 262  |
|         | 11                |                    |     |      |     |      |      | 296  | 28   | 349  | 82   | 455  | 188  | 594  | 326  | 556           | 288  |
|         | 12                |                    |     |      |     |      |      |      |      | 323  | 31   | 429  | 137  | 567  | 275  | 606           | 314  |
| F89-009 | 4                 | 337                | 257 | 514  | 425 | 682  | 593  | 771  | 682  | 850  | 762  | 1019 | 939  | 1240 | 1160 | 257           | 168  |
|         | 5                 | 292                | 186 | 469  | 363 | 638  | 531  | 726  | 620  | 806  | 700  | 983  | 868  | 1204 | 1089 | 319           | 213  |
|         | 6                 | 254                | 124 | 424  | 295 | 595  | 466  | 680  | 551  | 765  | 636  | 936  | 807  | 1158 | 1029 | 388           | 258  |
|         | 7                 | 210                | 60  | 381  | 230 | 552  | 401  | 637  | 486  | 722  | 572  | 893  | 742  | 1115 | 964  | 452           | 301  |
|         | 8                 |                    |     | 338  | 166 | 509  | 336  | 594  | 422  | 679  | 507  | 850  | 678  | 1072 | 900  | 517           | 344  |
|         | 9                 |                    |     | 295  | 101 | 466  | 272  | 551  | 357  | 636  | 443  | 807  | 613  | 1029 | 835  | 581           | 388  |
|         | 10                |                    |     |      |     | 423  | 207  | 508  | 293  | 593  | 378  | 764  | 549  | 986  | 770  | 646           | 431  |
|         | 11                |                    |     |      |     | 380  | 143  | 465  | 228  | 550  | 313  | 721  | 484  | 943  | 706  | 710           | 474  |
|         | 12                |                    |     |      |     |      |      | 422  | 163  | 507  | 249  | 678  | 419  | 900  | 641  | 775           | 517  |
| F89-014 | 4                 | 531                | 407 | 806  | 673 | 1072 | 939  | 1204 | 1072 | 1337 | 1204 | 1603 | 1470 | 1948 | 1816 | 399           | 266  |
|         | 5                 | 469                | 310 | 735  | 576 | 1001 | 841  | 1134 | 974  | 1266 | 1107 | 1532 | 1373 | 1886 | 1718 | 496           | 337  |
|         | 6                 | 402                | 207 | 669  | 474 | 936  | 741  | 1069 | 874  | 1202 | 1008 | 1469 | 1274 | 1816 | 1621 | 594           | 399  |
|         | 7                 | 335                | 108 | 602  | 375 | 869  | 642  | 1002 | 775  | 1136 | 909  | 1403 | 1175 | 1750 | 1522 | 693           | 465  |
|         | 8                 |                    |     | 536  | 276 | 803  | 543  | 936  | 676  | 1069 | 810  | 1336 | 1076 | 1683 | 1423 | 792           | 532  |
|         | 9                 |                    |     | 469  | 177 | 736  | 444  | 870  | 577  | 1003 | 711  | 1270 | 978  | 1617 | 1324 | 891           | 598  |
|         | 10                |                    |     |      |     | 670  | 345  | 803  | 478  | 937  | 612  | 1203 | 879  | 1550 | 1226 | 990           | 665  |
|         | 11                |                    |     |      |     | 603  | 246  | 737  | 379  | 870  | 513  | 1137 | 780  | 1484 | 1127 | 1089          | 731  |
|         | 12                |                    |     |      |     |      |      | 670  | 280  | 804  | 414  | 1070 | 681  | 1417 | 1028 | 1188          | 798  |
| F89-020 | 4                 | 762                | 549 | 1151 | 948 | 1541 | 1337 | 1736 | 1532 | 1931 | 1727 | 2320 | 2117 | 2834 | 2622 | 620           | 416  |
|         | 5                 | 655                | 399 | 1045 | 788 | 1435 | 1178 | 1630 | 1373 | 1824 | 1568 | 2223 | 1957 | 2728 | 2471 | 779           | 514  |
|         | 6                 | 553                | 243 | 943  | 633 | 1334 | 1024 | 1530 | 1220 | 1725 | 1415 | 2116 | 1806 | 2624 | 2314 | 930           | 620  |
|         | 7                 | 449                | 88  | 840  | 478 | 1231 | 869  | 1426 | 1065 | 1622 | 1260 | 2013 | 1651 | 2521 | 2159 | 1085          | 723  |
|         | 8                 |                    |     | 737  | 323 | 1128 | 714  | 1323 | 910  | 1518 | 1105 | 1909 | 1496 | 2418 | 2004 | 1240          | 827  |
|         | 9                 |                    |     | 633  | 168 | 1024 | 559  | 1220 | 755  | 1415 | 950  | 1806 | 1341 | 2314 | 1849 | 1395          | 930  |
|         | 10                |                    |     |      |     | 921  | 404  | 1116 | 600  | 1312 | 795  | 1703 | 1186 | 2211 | 1694 | 1550          | 1033 |
|         | 11                |                    |     |      |     | 818  | 249  | 1013 | 445  | 1208 | 640  | 1599 | 1031 | 2107 | 1539 | 1705          | 1137 |
|         | 12                |                    |     |      |     |      |      | 910  | 290  | 1105 | 485  | 1496 | 876  | 2004 | 1384 | 1860          | 1240 |

# KEYSTONE F89 PNEUMATIC QUARTER-TURN ACTUATOR

GENERAL PURPOSE / HAZARDOUS AREA

TABLE 11 - SR TORQUE (in-lb) continued

| Model           | Number of springs | Air pressure (psi) |      |       |       |       |       |       |       |       |       |       |       | Spring torque |       |       |       |
|-----------------|-------------------|--------------------|------|-------|-------|-------|-------|-------|-------|-------|-------|-------|-------|---------------|-------|-------|-------|
|                 |                   | 40                 |      | 60    |       | 70    |       | 80    |       | 90    |       | 100   |       | 120           |       | SST   | SET   |
|                 |                   | AST                | AET  | AST   | AET   | AST   | AET   | AST   | AET   | AST   | AET   | AST   | AET   | AST           | AET   |       |       |
| F89-032/033     | 4                 | 1187               | 850  | 1798  | 1470  | 2409  | 2081  | 2719  | 2391  | 3020  | 2692  | 3640  | 3312  | 4437          | 4109  | 983   | 655   |
|                 | 5                 | 1019               | 611  | 1630  | 1222  | 2250  | 1833  | 2551  | 2143  | 2861  | 2444  | 3472  | 3064  | 4269          | 3861  | 1231  | 824   |
|                 | 6                 | 854                | 360  | 1467  | 974   | 2081  | 1587  | 2388  | 1894  | 2695  | 2201  | 3308  | 2815  | 4106          | 3612  | 1481  | 987   |
|                 | 7                 | 689                | 113  | 1303  | 727   | 1916  | 1341  | 2223  | 1647  | 2530  | 1954  | 3144  | 2568  | 3942          | 3366  | 1728  | 1152  |
|                 | 8                 |                    |      | 1138  | 480   | 1752  | 1094  | 2059  | 1401  | 2366  | 1707  | 2979  | 2321  | 3777          | 3119  | 1974  | 1316  |
|                 | 9                 |                    |      | 974   | 233   | 1587  | 847   | 1894  | 1154  | 2201  | 1461  | 2815  | 2074  | 3612          | 2872  | 2221  | 1481  |
|                 | 10                |                    |      |       |       | 1423  | 600   | 1730  | 907   | 2037  | 1214  | 2650  | 1828  | 3448          | 2625  | 2468  | 1645  |
|                 | 11                |                    |      |       |       | 1258  | 353   | 1565  | 660   | 1872  | 967   | 2486  | 1581  | 3283          | 2378  | 2715  | 1810  |
|                 | 12                |                    |      |       |       |       |       | 1401  | 413   | 1707  | 720   | 2321  | 1334  | 3119          | 2132  | 2962  | 1974  |
| F89-051/052     | 4                 | 1727               | 1196 | 2657  | 2126  | 3587  | 3056  | 4047  | 3525  | 4517  | 3985  | 5447  | 4915  | 6651          | 6120  | 1594  | 1063  |
|                 | 5                 | 1461               | 797  | 2391  | 1727  | 3321  | 2657  | 3791  | 3126  | 4251  | 3587  | 5181  | 4517  | 6386          | 5730  | 1993  | 1328  |
|                 | 6                 | 1198               | 402  | 2127  | 1332  | 3057  | 2261  | 3522  | 2726  | 3986  | 3191  | 4916  | 4120  | 6124          | 5329  | 2386  | 1591  |
|                 | 7                 | 933                | 5    | 1862  | 934   | 2792  | 1864  | 3256  | 2328  | 3721  | 2793  | 4651  | 3723  | 5859          | 4931  | 2784  | 1856  |
|                 | 8                 |                    |      | 1597  | 536   | 2526  | 1466  | 2991  | 1931  | 3456  | 2395  | 4386  | 3325  | 5594          | 4533  | 3182  | 2121  |
|                 | 9                 |                    |      | 1332  | 139   | 2261  | 1068  | 2726  | 1533  | 3191  | 1998  | 4120  | 2927  | 5329          | 4136  | 3580  | 2386  |
|                 | 10                |                    |      |       |       | 1996  | 670   | 2461  | 1135  | 2926  | 1600  | 3855  | 2530  | 5064          | 3738  | 3977  | 2652  |
|                 | 11                |                    |      |       | 1731  | 273   | 2196  | 737   | 2661  | 1202  | 3590  | 2132  | 4799  | 3340          | 4375  | 2917  |       |
|                 | 12                |                    |      |       |       |       |       | 1931  | 340   | 2395  | 805   | 3325  | 1734  | 4533          | 2942  | 4773  | 3182  |
| F89-084/085     | 4                 | 2916               | 2048 | 4467  | 3599  | 6018  | 5150  | 6793  | 5925  | 7568  | 6700  | 9119  | 8251  | 11135         | 10267 | 2604  | 1736  |
|                 | 5                 | 2482               | 1393 | 4033  | 2944  | 5584  | 4494  | 6359  | 5270  | 7134  | 6045  | 8685  | 7596  | 10701         | 9612  | 3259  | 2170  |
|                 | 6                 | 2048               | 738  | 3599  | 2288  | 5150  | 3839  | 5925  | 4614  | 6700  | 5390  | 8251  | 6940  | 10267         | 8956  | 3915  | 2604  |
|                 | 7                 |                    |      | 3156  | 1642  | 4707  | 3192  | 5482  | 3968  | 6258  | 4743  | 7808  | 6294  | 9824          | 8310  | 4561  | 3047  |
|                 | 8                 |                    |      | 2722  | 986   | 4273  | 2537  | 5048  | 3312  | 5824  | 4088  | 7374  | 5638  | 9390          | 7654  | 5217  | 3481  |
|                 | 9                 |                    |      |       |       | 3839  | 1882  | 4614  | 2657  | 5390  | 3432  | 6940  | 4983  | 8956          | 6999  | 5872  | 3915  |
|                 | 10                |                    |      |       |       | 3405  | 1235  | 4180  | 2010  | 4956  | 2786  | 6506  | 4337  | 8522          | 6352  | 6518  | 4349  |
|                 | 11                |                    |      |       | 2971  | 580   | 3746  | 1355  | 4522  | 2130  | 6072  | 3681  | 8088  | 5697          | 7174  | 4783  |       |
|                 | 12                |                    |      |       |       |       |       | 3312  | 709   | 4088  | 1484  | 5638  | 3035  | 7654          | 5051  | 7820  | 5217  |
| F89-139/140/141 | 4                 | 4853               | 3400 | 7436  | 5983  | 10018 | 8566  | 11310 | 9857  | 12601 | 11149 | 15184 | 13732 | 18542         | 17090 | 4349  | 2896  |
|                 | 5                 | 4126               | 2320 | 6709  | 4903  | 9292  | 7485  | 10584 | 8777  | 11875 | 10068 | 14458 | 12651 | 17816         | 16009 | 5429  | 3622  |
|                 | 6                 | 3400               | 1230 | 5983  | 3813  | 8566  | 6396  | 9857  | 7688  | 11149 | 8979  | 13732 | 11562 | 17090         | 14920 | 6518  | 4349  |
|                 | 7                 |                    |      | 5266  | 2724  | 7849  | 5307  | 9140  | 6598  | 10431 | 7890  | 13014 | 10473 | 16372         | 13830 | 7608  | 5066  |
|                 | 8                 |                    |      | 4539  | 1643  | 7122  | 4226  | 8414  | 5518  | 9705  | 6809  | 12288 | 9392  | 15646         | 12750 | 8688  | 5792  |
|                 | 9                 |                    |      |       |       | 6396  | 3137  | 7688  | 4428  | 8979  | 5720  | 11562 | 8303  | 14920         | 11660 | 9778  | 6518  |
|                 | 10                |                    |      |       |       | 5670  | 2047  | 6961  | 3339  | 8253  | 4630  | 10836 | 7213  | 14193         | 10571 | 10867 | 7245  |
|                 | 11                |                    |      |       | 4944  | 967   | 6235  | 2258  | 7527  | 3550  | 10109 | 6133  | 13467 | 9491          | 11948 | 7971  |       |
|                 | 12                |                    |      |       |       |       | 5518  | 1169  | 6809  | 2461  | 9392  | 5043  | 12750 | 8401          | 13037 | 8688  |       |
| F89-240         | 4                 | 8451               | 5989 | 12903 | 10441 | 17356 | 14894 | 19582 | 17120 | 21808 | 19346 | 26261 | 23798 | 32049         | 29587 | 7369  | 4907  |
|                 | 5                 | 7220               | 4155 | 11672 | 8608  | 16125 | 13060 | 18351 | 15286 | 20577 | 17513 | 25030 | 21965 | 30818         | 27753 | 9202  | 6138  |
|                 | 6                 | 5989               | 2313 | 10441 | 6766  | 14894 | 11218 | 17120 | 13444 | 19346 | 15671 | 23798 | 20123 | 29587         | 25911 | 11044 | 7369  |
|                 | 7                 |                    |      | 9219  | 4923  | 13671 | 9376  | 15898 | 11602 | 18124 | 13828 | 22576 | 18281 | 28364         | 24069 | 12886 | 8591  |
|                 | 8                 |                    |      | 7988  | 3081  | 12440 | 7534  | 14667 | 9760  | 16893 | 11986 | 21345 | 16439 | 27133         | 22227 | 14729 | 9822  |
|                 | 9                 |                    |      |       |       | 11218 | 5692  | 13444 | 7918  | 15671 | 10144 | 20123 | 14596 | 25911         | 20385 | 16571 | 11044 |
|                 | 10                |                    |      |       |       | 9987  | 3849  | 12213 | 6076  | 14439 | 8302  | 18892 | 12754 | 24680         | 18543 | 18413 | 12275 |
|                 | 11                |                    |      |       |       | 8765  | 2007  | 10991 | 4233  | 13217 | 6460  | 17670 | 10912 | 23458         | 16700 | 20255 | 13497 |
|                 |                   | 12                 |      |       |       |       |       | 9760  | 2391  | 11986 | 4618  | 16439 | 9070  | 22227         | 14858 | 22097 | 14729 |

# KEYSTONE F89 PNEUMATIC QUARTER-TURN ACTUATOR

## ORDERING GUIDE

| Example:                 | 89E                           | 020        | 03                         | 08         | N14                                    | N | 2 | M | 00 | M10 | D25 |
|--------------------------|-------------------------------|------------|----------------------------|------------|--|---|---|---|----|-----|-----|
| <b>Figure number</b>     |                               |            |                            |            |  |   |   |   |    |     |     |
| <b>89D</b>               | ISO 5211 flange and shaft     |            |                            |            |  |   |   |   |    |     |     |
| <b>89E</b>               | ISO flange and Keystone shaft |            |                            |            |  |   |   |   |    |     |     |
| <b>89U</b>               | Keystone flange and shaft     |            |                            |            |  |   |   |   |    |     |     |
| <b>Model/Size</b>        |                               |            |                            |            |  |   |   |   |    |     |     |
| <b>002</b>               | 002                           | <b>020</b> | 020                        | <b>085</b> | 085                                    |   |   |   |    |     |     |
| <b>003</b>               | 003                           | <b>032</b> | 032                        | <b>140</b> | 140                                    |   |   |   |    |     |     |
| <b>004</b>               | 004                           | <b>033</b> | 033                        | <b>141</b> | 141                                    |   |   |   |    |     |     |
| <b>006</b>               | 006                           | <b>051</b> | 051                        | <b>240</b> | 240                                    |   |   |   |    |     |     |
| <b>009</b>               | 009                           | <b>052</b> | 052                        |            |  |   |   |   |    |     |     |
| <b>014</b>               | 014                           | <b>084</b> | 084                        |            |  |   |   |   |    |     |     |
| <b>Action</b>            |                               |            |                            |            |  |   |   |   |    |     |     |
| <b>01</b>                | DA                            |            |                            |            |  |   |   |   |    |     |     |
| <b>03</b>                | SR FC CW (std)                |            |                            |            |  |   |   |   |    |     |     |
| <b>04</b>                | SR FC CCW                     |            |                            |            |  |   |   |   |    |     |     |
| <b>Spring rating</b>     |                               |            |                            |            |  |   |   |   |    |     |     |
| <b>04</b>                | 4 springs                     | <b>08</b>  | 8 springs                  | <b>12</b>  | 12 springs                             |   |   |   |    |     |     |
| <b>05</b>                | 5 springs                     | <b>09</b>  | 9 springs                  | <b>XX</b>  | not applicable                         |   |   |   |    |     |     |
| <b>06</b>                | 6 springs                     | <b>10</b>  | 10 springs                 |            |  |   |   |   |    |     |     |
| <b>07</b>                | 7 springs                     | <b>11</b>  | 11 springs                 |            |  |   |   |   |    |     |     |
| <b>Air connection</b>    |                               |            |                            |            |  |   |   |   |    |     |     |
| <b>N14</b>               | ¼" NPT                        | <b>P14</b> | ¼" BSPP                    |            |  |   |   |   |    |     |     |
| <b>N38</b>               | ⅜" NPT                        | <b>P38</b> | ⅜" BSPP                    |            |  |   |   |   |    |     |     |
| <b>Temperature range</b> |                               |            |                            |            |  |   |   |   |    |     |     |
| <b>H</b>                 | High temp (FKM)               |            |                            |            |  |   |   |   |    |     |     |
| <b>N</b>                 | Standard (NBR)                |            |                            |            |  |   |   |   |    |     |     |
| <b>L</b>                 | Low temp                      |            |                            |            |  |   |   |   |    |     |     |
| <b>Travel stops</b>      |                               |            |                            |            |  |   |   |   |    |     |     |
| <b>2</b>                 | Dual shaft (std)              |            |                            |            |  |   |   |   |    |     |     |
| <b>3</b>                 | End cap (single)              |            |                            |            |  |   |   |   |    |     |     |
| <b>4</b>                 | End cap (double)              |            |                            |            |  |   |   |   |    |     |     |
| <b>Flange threading</b>  |                               |            |                            |            |  |   |   |   |    |     |     |
| <b>M</b>                 | Metric                        |            |                            |            |  |   |   |   |    |     |     |
| <b>U</b>                 | Imperial                      |            |                            |            |  |   |   |   |    |     |     |
| <b>Variant</b>           |                               |            |                            |            |  |   |   |   |    |     |     |
| <b>00</b>                | Standard                      |            |                            |            |  |   |   |   |    |     |     |
| <b>A4</b>                | A4 SS bolts                   |            |                            |            |  |   |   |   |    |     |     |
| <b>Valve flange*</b>     |                               |            |                            |            |  |   |   |   |    |     |     |
| <b>F03</b>               | PCD 36 mm (ISO 5211)          | <b>M05</b> | F03 + F05 (ISO 5211)       | <b>U1C</b> | PCD 1.75" (Keystone 45 degrees)        |   |   |   |    |     |     |
| <b>F04</b>               | PCD 42 mm (ISO 5211)          | <b>M07</b> | F05 + F07 (ISO 5211)       | <b>U34</b> | PCD 3.25" (Keystone 45 degrees)        |   |   |   |    |     |     |
| <b>F05</b>               | PCD 50 mm (ISO 5211)          | <b>M10</b> | F07 + F10 + F12 (ISO 5211) | <b>U50</b> | PCD 5.00" (Keystone 45 degrees)        |   |   |   |    |     |     |
| <b>F07</b>               | PCD 70 mm (ISO 5211)          | <b>M12</b> | F10 + F12 (ISO 5211)       | <b>U68</b> | PCD 6.50" (Keystone 45 degrees)        |   |   |   |    |     |     |
| <b>F10</b>               | PCD 102 mm (ISO 5211)         | <b>M14</b> | F10 + F14 (ISO 5211)       |            |  |   |   |   |    |     |     |
| <b>F12</b>               | PCD 125 mm (ISO 5211)         | <b>M16</b> | F12 + F16 (ISO 5211)       | <b>C34</b> | PCD 1.75 + 3.25" (Keystone 45 degrees) |   |   |   |    |     |     |
| <b>F14</b>               | PCD 140 mm (ISO 5211)         |            |                            | <b>C50</b> | PCD 3.25 + 5.00" (Keystone 45 degrees) |   |   |   |    |     |     |
| <b>F16</b>               | PCD 165 mm (ISO 5211)         |            |                            | <b>C68</b> | PCD 5.00 + 6.50" (Keystone 45 degrees) |   |   |   |    |     |     |
| <b>Shaft*</b>            |                               |            |                            |            |  |   |   |   |    |     |     |
| <b>S11</b>               | Star 11                       | <b>D12</b> | E1 - DD12 x 8              | <b>P06</b> | DD ⅜" x ¼" [9.53 x 6.35 mm]            |   |   |   |    |     |     |
| <b>S14</b>               | Star 14                       | <b>D16</b> | E2 - DD16 x 11             | <b>P09</b> | DD ⅞" x ⅜" [14.29 x 9.53 mm]           |   |   |   |    |     |     |
| <b>S17</b>               | Star 17                       | <b>D20</b> | E3 - DD20 x 14             | <b>P0A</b> | DD ⅞" x 7/16" [15.88 x 11.1 mm]        |   |   |   |    |     |     |
| <b>S22</b>               | Star 22                       | <b>D25</b> | E4 - DD25 x 18             | <b>P0C</b> | DD ¾" x ½" [19.05 x 12.7 mm]           |   |   |   |    |     |     |
| <b>S27</b>               | Star 27                       | <b>D30</b> | E5 - DD30 x 22             | <b>P0E</b> | DD ⅞" x ⅝" [22.2 x 15.88 mm]           |   |   |   |    |     |     |
| <b>S36</b>               | Star 36                       | <b>M35</b> | E6 - 35K10                 | <b>U0D</b> | Dia 1⅜"; K 3/16 x 3/16" [20.6K4.78 mm] |   |   |   |    |     |     |
| <b>S46</b>               | Star 46                       | <b>M40</b> | E7 - 40K12                 | <b>U10</b> | Dia 1"; K 1½x¼" [25.4K6.35 mm]         |   |   |   |    |     |     |
| <b>S55</b>               | Star 55                       | <b>M44</b> | E8 - 44K12                 | <b>U12</b> | Dia 1⅞"; K ¼x¼" [28.8K6.35 mm]         |   |   |   |    |     |     |
| <b>S75</b>               | Star 75                       | <b>M50</b> | E9 - 50K14                 | <b>U16</b> | Dia 1⅞"; K 5/16 x 5/16" [34.9K7.94 mm] |   |   |   |    |     |     |
|                          |                               | <b>M60</b> | E0 - 60K18                 | <b>U1A</b> | Dia 1⅞"; K 3/8 x 3/8" [41.3K9.53 mm]   |   |   |   |    |     |     |
|                          |                               | <b>M70</b> | EA - 70K20                 | <b>U1E</b> | Dia 1⅞"; K ½ x 3/8" [47.6K12.7 mm]     |   |   |   |    |     |     |
|                          |                               | <b>M80</b> | EB - 80K22                 | <b>U24</b> | Dia 2¼"; K ½ x 3/8" [57.2K12.7 mm]     |   |   |   |    |     |     |
|                          |                               | <b>M90</b> | EC - 90K25                 | <b>U26</b> | Dia 2⅞"; K 5/8" [63.3K15.9 mm]         |   |   |   |    |     |     |
|                          |                               | <b>MA0</b> | ED - 100K28                | <b>U2C</b> | Dia 2¾"; K 5/8" [69.9K15.9 mm]         |   |   |   |    |     |     |
|                          |                               | <b>MS0</b> | Bore 30 x K8 (Keystone)    | <b>U38</b> | Dia 3½"; K 7/8" [88.9K22.23 mm]        |   |   |   |    |     |     |

\* Please consult technical pages for the specific flange and shaft details per model.



## **PENTAIR VALVES & CONTROLS**

[www.pentair.com/valves](http://www.pentair.com/valves)

All Pentair trademarks and logos are owned by Pentair plc. All other brand or product names are trademarks or registered marks of their respective owners. Because we are continuously improving our products and services, Pentair reserves the right to change product designs and specifications without notice. Pentair is an equal opportunity employer. © 2015 Pentair plc. All rights reserved.